

TO-92 PNP Transistor

FEATURES

- Switching and Amplification in High Voltage
- Applications such as Telephony
- Low Current
- High Voltage

MAXIMUM RATINGS ($T_a=25^\circ\text{C}$ unless otherwise noted)

Symbol	Parameter	Value	Unit
V_{CBO}	Collector-Base Voltage	-160	V
V_{CEO}	Collector-Emitter Voltage	-150	V
V_{EBO}	Emitter-Base Voltage	-5	V
I_C	Collector Current	-0.6	A
P_C	Collector Power Dissipation	625	mW
$R_{\theta JA}$	Thermal Resistance From Junction To Ambient	200	$^\circ\text{C/W}$
T_j	Junction Temperature	150	$^\circ\text{C}$
T_{stg}	Storage Temperature	-55~+150	$^\circ\text{C}$

TO - 92

1. EMITTER
2. BASE
3. COLLECTOR

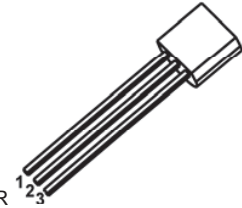

ELECTRICAL CHARACTERISTICS ($T_a=25^\circ\text{C}$ unless otherwise specified)

Parameter	Symbol	Test conditions	Min	Typ	Max	Unit
Collector-base breakdown voltage	$V_{(BR)CBO}$	$I_C = -0.1\text{mA}, I_E = 0$	-160			V
Collector-emitter breakdown voltage	$V_{(BR)CEO}$	$I_C = -1\text{mA}, I_B = 0$	-150			V
Emitter-base breakdown voltage	$V_{(BR)EBO}$	$I_E = -0.01\text{mA}, I_C = 0$	-5			V
Collector cut-off current	I_{CBO}	$V_{CB} = -120\text{V}, I_E = 0$			-50	nA
Emitter cut-off current	I_{EBO}	$V_{EB} = -3\text{V}, I_C = 0$			-50	nA
DC current gain	$h_{FE(1)}$	$V_{CE} = 5\text{V}, I_C = 1\text{mA}$	80			
	$h_{FE(2)}$	$V_{CE} = 5\text{V}, I_C = 10\text{mA}$	60		300	
	$h_{FE(3)}$	$V_{CE} = 5\text{V}, I_C = 50\text{mA}$	50			
Collector-emitter saturation voltage	$V_{CE(sat)}$	$I_C = -50\text{mA}, I_B = -5\text{mA}$			-0.5	V
Base-emitter saturation voltage	$V_{BE(sat)}$	$I_C = -50\text{mA}, I_B = -5\text{mA}$			-1	V
Transition frequency	f_T	$V_{CE} = -5\text{V}, I_C = -10\text{mA}, f = 30\text{MHz}$	100		300	MHz

*Pulse test: pulse width $\leq 300\mu\text{s}$, duty cycles $\leq 2.0\%$.

CLASSIFICATION OF $h_{FE(2)}$

RANK		A	B	C
RANGE	60-300	100-150	150-200	200-300

Typical Characteristics

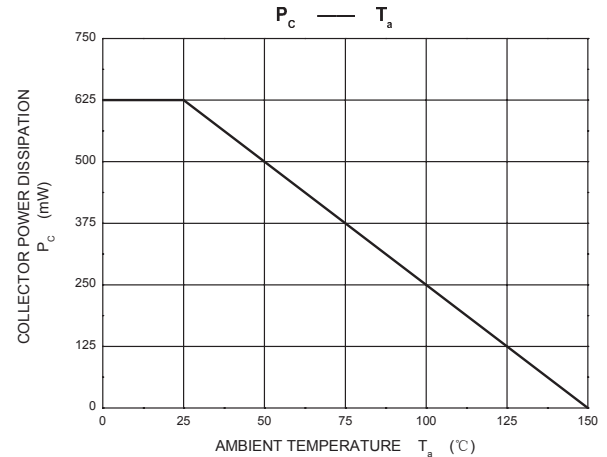
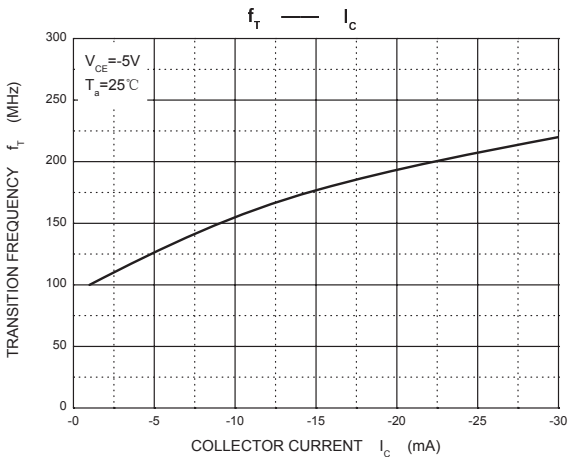
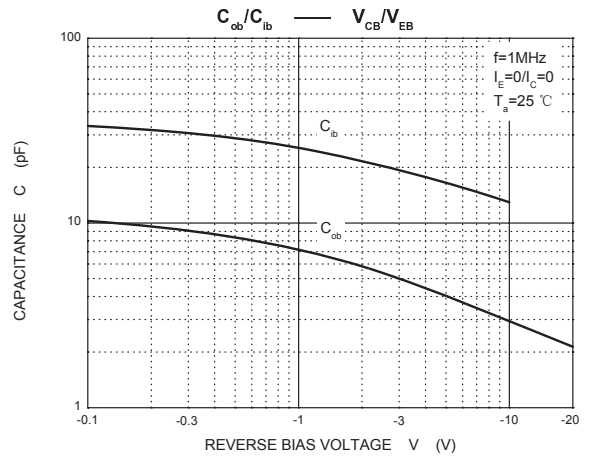
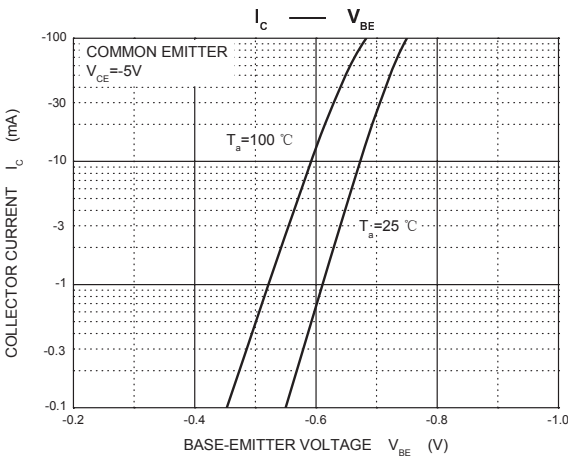
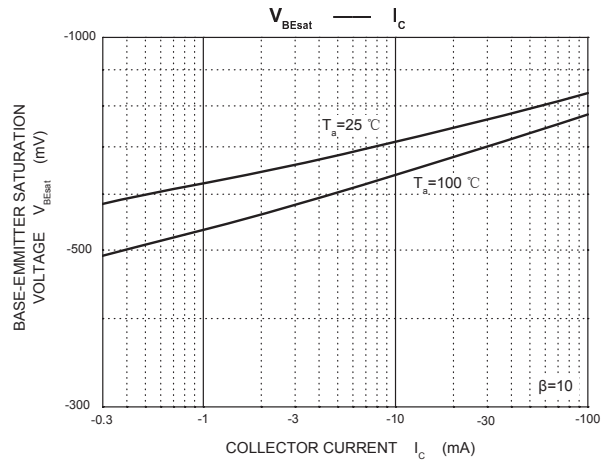
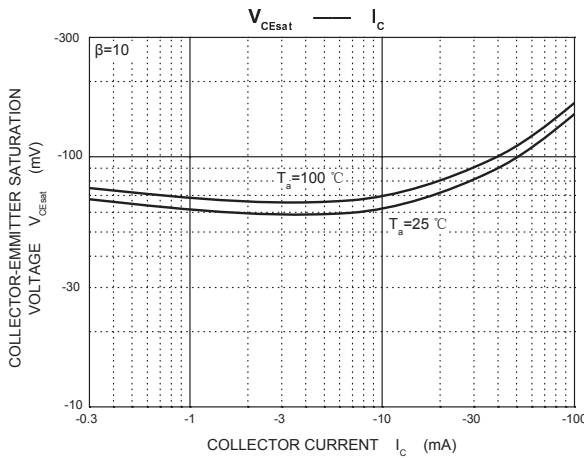
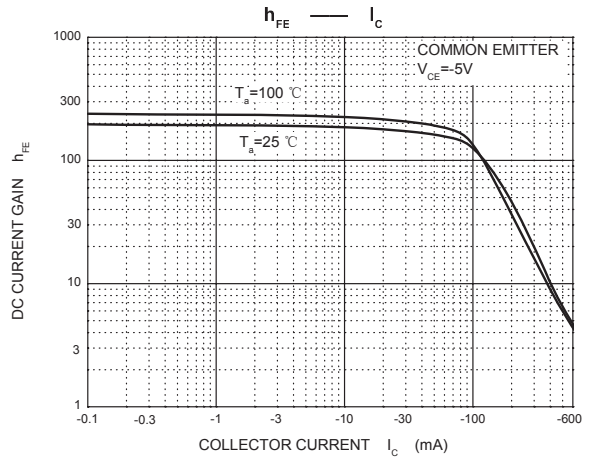
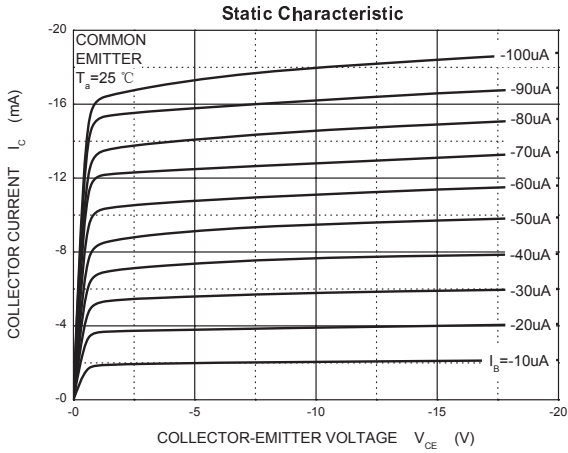

TO-92 PACKAGE OUTLINE DIMENSIONS

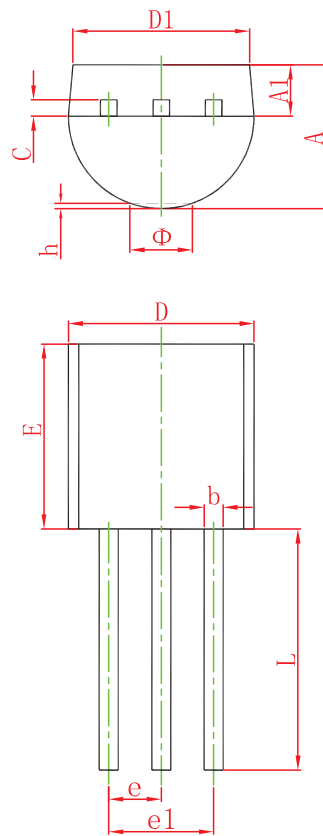

Symbol	Dimensions In Millimeters		Dimensions In Inches	
	Min.	Max.	Min.	Max.
A	3.300	3.700	0.130	0.146
A1	1.100	1.400	0.043	0.055
b	0.380	0.550	0.015	0.022
c	0.360	0.510	0.014	0.020
D	4.300	4.700	0.169	0.185
D1	3.430		0.135	
E	4.300	4.700	0.169	0.185
e	1.270 TYP.		0.050 TYP.	
e1	2.440	2.640	0.096	0.104
L	14.100	14.500	0.555	0.571
Φ		1.600		0.063
h	0.000	0.380	0.000	0.015

Package	Box	Box Size(mm)	Carton	Carton Size(mm)
TO-92	2000 pcs	333×162×43	20,000 pcs	350×340×250

DISCLAIMER NOTICE

Rectron Inc reserves the right to make changes without notice to any product specification herein, to make corrections, modifications, enhancements or other changes. Rectron Inc or anyone on its behalf assumes no responsibility or liability for any errors or inaccuracies. Data sheet specifications and its information contained are intended to provide a product description only. "Typical" parameters which may be included on RECTRON data sheets and/ or specifications can and do vary in different applications and actual performance may vary over time. Rectron Inc does not assume any liability arising out of the application or use of any product or circuit.

Rectron products are not designed, intended or authorized for use in medical, life-saving implant or other applications intended for life-sustaining or other related applications where a failure or malfunction of component or circuitry may directly or indirectly cause injury or threaten a life without expressed written approval of Rectron Inc. Customers using or selling Rectron components for use in such applications do so at their own risk and shall agree to fully indemnify Rectron Inc and its subsidiaries harmless against all claims, damages and expenditures.

Mouser Electronics

Authorized Distributor

Click to View Pricing, Inventory, Delivery & Lifecycle Information:

[Rectron:](#)

[2N5401-T](#) [2N5401-F](#) [2N5401](#)